

Platinum and PTFE Prosthesis for Stapedotomy and Stapedectomy

CODE
SPL 03.07

PTFE: Polytetrafluorethylene

This prosthesis is made entirely of 999‰ fine platinum ribbon.

Platinum is a highly malleable and well tolerated metal.

The hook has three transverse grooves: under slight pressure of a small forceps it bends only in the three points corresponding to the grooves

gently wrapping the long process of the incus without causing ischemia and without the danger of anomalous closures.

The PTFE stem is suitable for stapedotomy procedures.

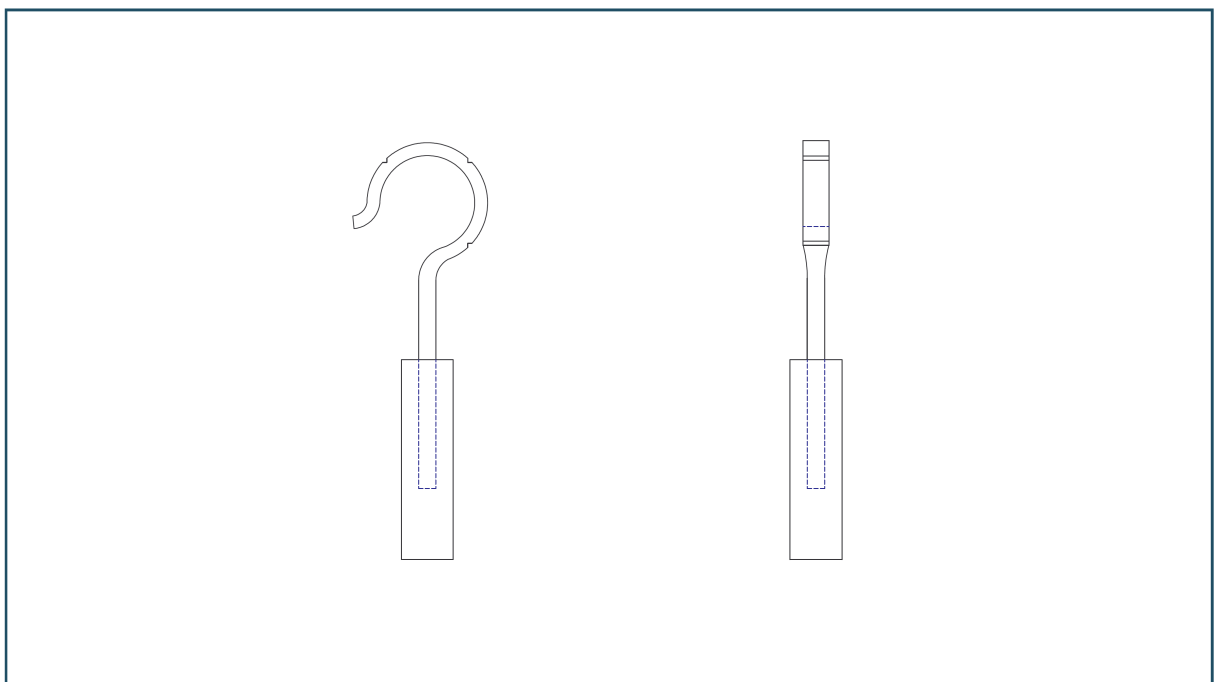

Dimensions

Total length (mm):

4.00 - 4.25 - 4.50 - 4.75

5.00 - 5.25 - 5.50 - 5.75

Piston diameter: 0.60 mm

Packaging

Dispenser box containing 6 sterile, individually packaged implants.

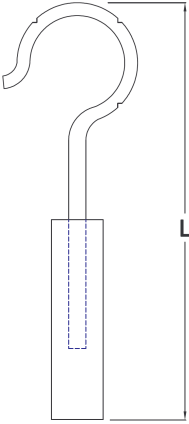
	Total length (L) mm	Code
	4.00	SPL 03.07.400
4.25	SPL 03.07.425	
4.50	SPL 03.07.450	
4.75	SPL 03.07.475	
5.00	SPL 03.07.500	
5.25	SPL 03.07.525	
5.50	SPL 03.07.550	
5.75	SPL 03.07.575	

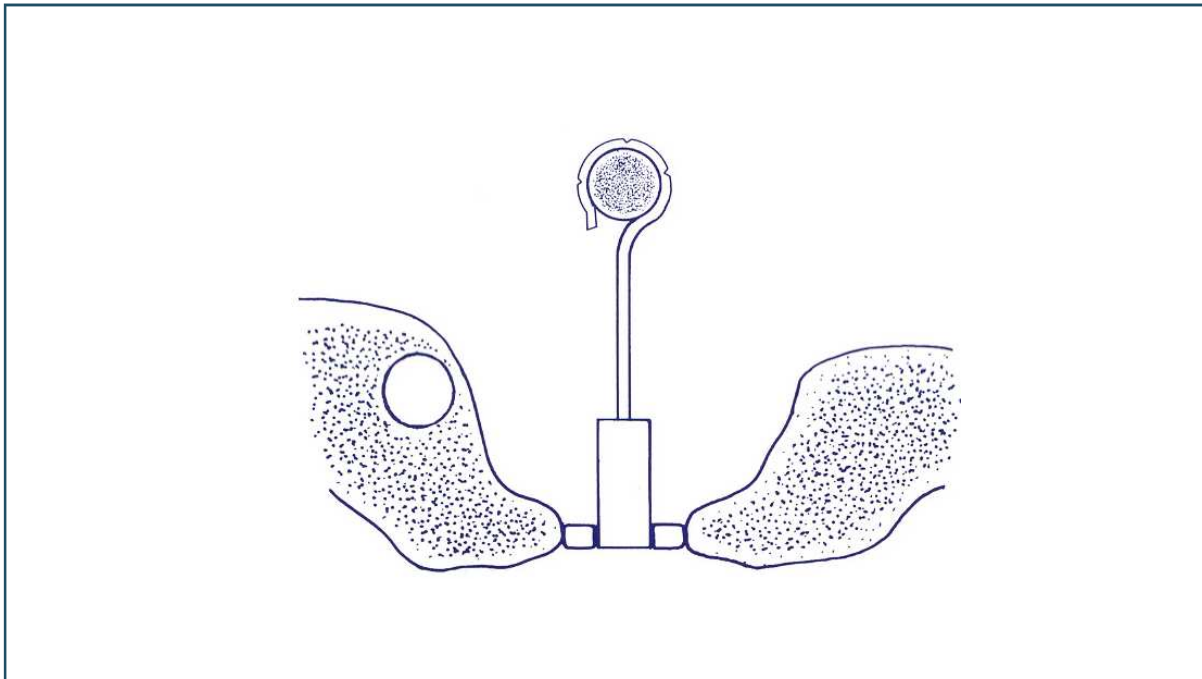

Trimmable Platinum and Ptfе Prosthesis for Stapedotomy and Stapedectomy

CODE
SPL 03.07S

PTFE: Polytetrafluorethylene

Dimensions
Total length: 7.0 mm.
trimmable to 4.25 mm.
Piston diameter: 0.6 mm.

Packaging
Dispenser box containing 6
sterile, individually
packaged implants.

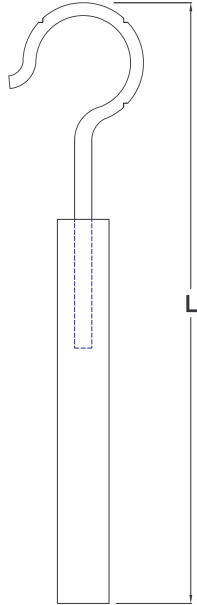
	Total length (L) mm	Code
	7.00 mm trimmable to 4.25 mm	SPL 03.07S

Trimmable Platinum and Ptfе Prosthesis for Stapedotomy and Stapedectomy

CODE
SPL 03.08S

PTFE: Polytetrafluorethylene

Dimensions
Total length: 7.0 mm.
trimmable to 4.25 mm.
Piston diameter: 0.4 mm.

Packaging
Dispenser box containing 6
sterile, individually
packaged implants.

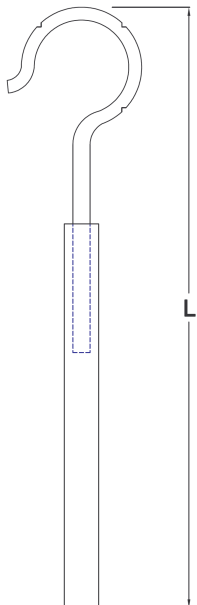
	Total length (L) mm	Code
	7.00 mm trimmable to 4.25 mm	SPL 03.08S

Trimnable Platinum and Ptfе Prosthesis for Stapedotomy and Stapedectomy

CODE
SPL 03.09S

PTFE: Polytetrafluorethylene

Dimensions

Total length: 7.00 mm.
trimmable to 4.25 mm.
Piston diameter: 0.5 mm.

Packaging

Dispenser box containing 6
sterile, individually
packaged implants.

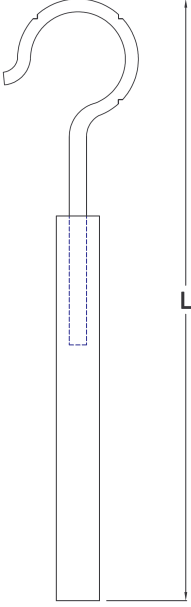
	Total length (L) mm	Code
	7.00 mm trimmable to 4.25 mm	SPL 03.09S

Trimmable Platinum and Ptfе Prosthesis for Stapedotomy and Stapedectomy

CODE
SPL 03.10S

PTFE: Polytetrafluorethylene

Dimensions

Total length: 7.00 mm.
trimmable to 4.25 mm.
Piston diameter: 0.8 mm.

Packaging

Dispenser box containing 6
sterile, individually
packaged implants.

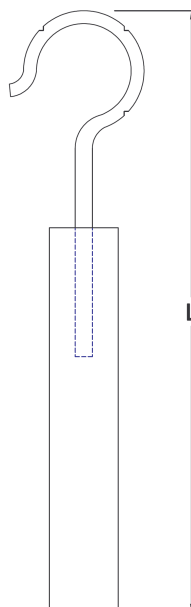
	Total length (L) mm	Code
	7.00 mm trimmable to 4.25 mm	SPL 03.10S

Platinum and PTFE Prosthesis for Stapedotomy and Stapedectomy

CODE
SPL 03.08

PTFE: Polytetrafluorethylene

This prosthesis is made entirely of 999‰ fine platinum ribbon.

Platinum is a highly malleable and well tolerated metal.

The hook has three transverse grooves: under slight pressure of a small forceps it bends only in the three points corresponding to the grooves

gently wrapping the long process of the incus without causing ischemia and without the danger of anomalous closures.

The PTFE stem is suitable for stapedotomy procedures.

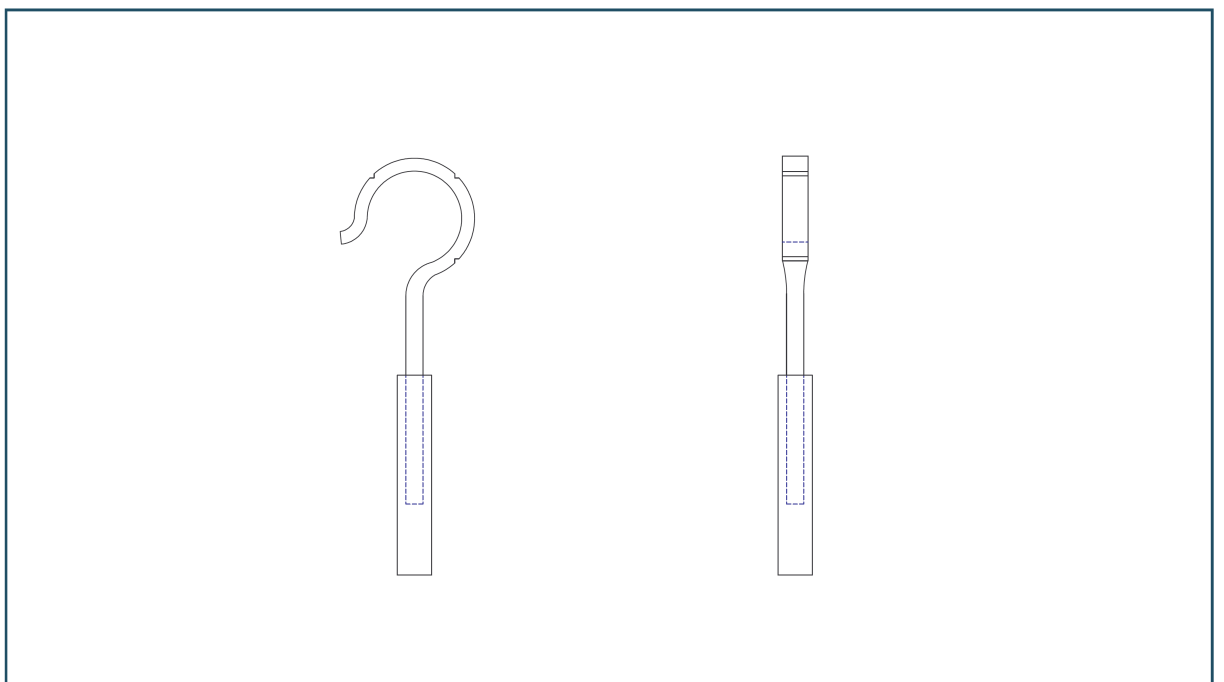

Dimensions

Total length (mm):

4.00 - 4.25 - 4.50 - 4.75

5.00 - 5.25 - 5.50 - 5.75

Piston diameter: 0.40 mm

Packaging

Dispenser box containing 6 sterile, individually packaged implants.

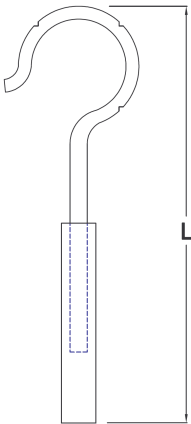
	Total length (L) mm	Code
	4.00	SPL 03.08.400
	4.25	SPL 03.08.425
	4.50	SPL 03.08.450
	4.75	SPL 03.08.475
	5.00	SPL 03.08.500
	5.25	SPL 03.08.525
	5.50	SPL 03.08.550
	5.75	SPL 03.08.575

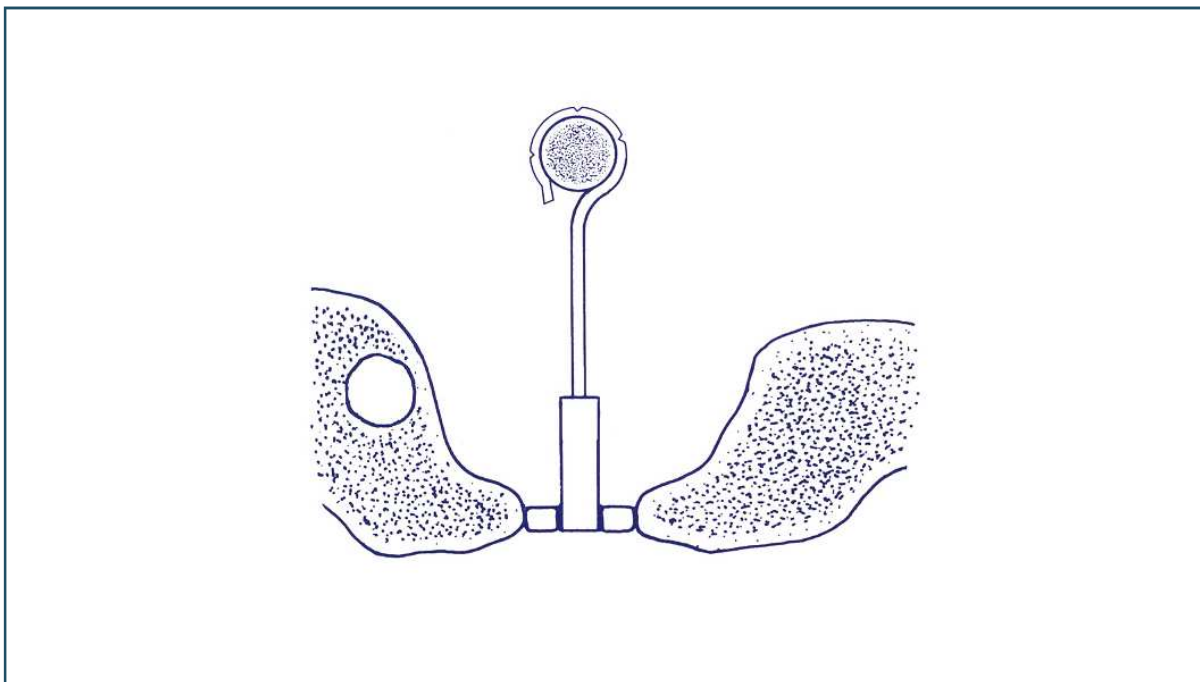

Platinum and PTFE Prosthesis for Stapedotomy and Stapedectomy

CODE
SPL 03.09

PTFE: Polytetrafluorethylene

This prosthesis is made entirely of 999‰ fine platinum ribbon.

Platinum is a highly malleable and well tolerated metal.

The hook has three transverse grooves: under slight pressure of a small forceps it bends only in the three points corresponding to the grooves

gently wrapping the long process of the incus without causing ischemia and without the danger of anomalous closures.

The PTFE stem is suitable for stapedotomy procedures.

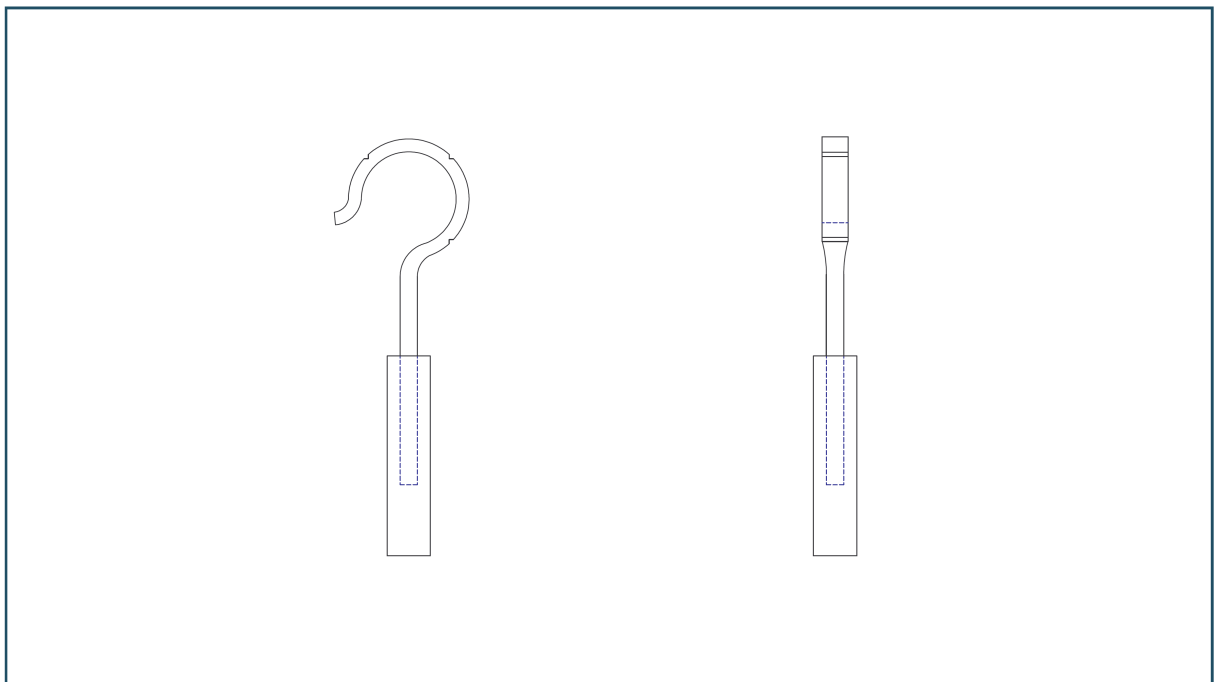

Dimensions

Total length (mm):

4.00 - 4.25 - 4.50 - 4.75

5.00 - 5.25 - 5.50 - 5.75

Piston diameter: 0.50 mm

Packaging

Dispenser box containing 6 sterile, individually packaged implants.

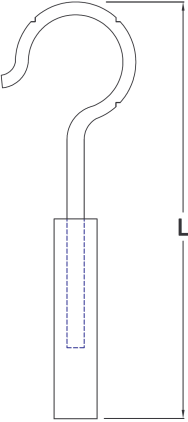
	Total length (L) mm	Code
	4.00	SPL 03.09.400
4.25	SPL 03.09.425	
4.50	SPL 03.09.450	
4.75	SPL 03.09.475	
5.00	SPL 03.09.500	
5.25	SPL 03.09.525	
5.50	SPL 03.09.550	
5.75	SPL 03.09.575	

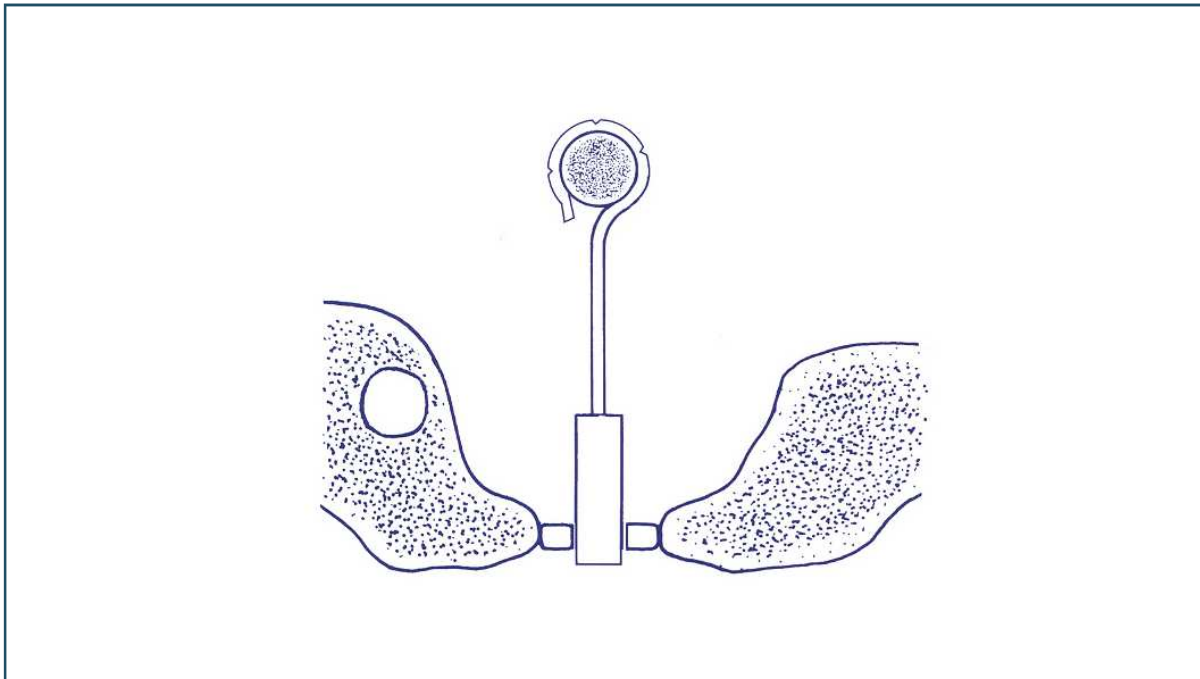

Platinum and PTFE Prosthesis for Stapedotomy and Stapedectomy

CODE
SPL 03.10

PTFE: Polytetrafluorethylene

This prosthesis is made entirely of 999‰ fine platinum ribbon.

Platinum is a highly malleable and well tolerated metal.

The hook has three transverse grooves: under slight pressure of a small forceps it bends only in the three points corresponding to the grooves

gently wrapping the long process of the incus without causing ischemia and without the danger of anomalous closures.

The PTFE stem is suitable for stapedotomy procedures.

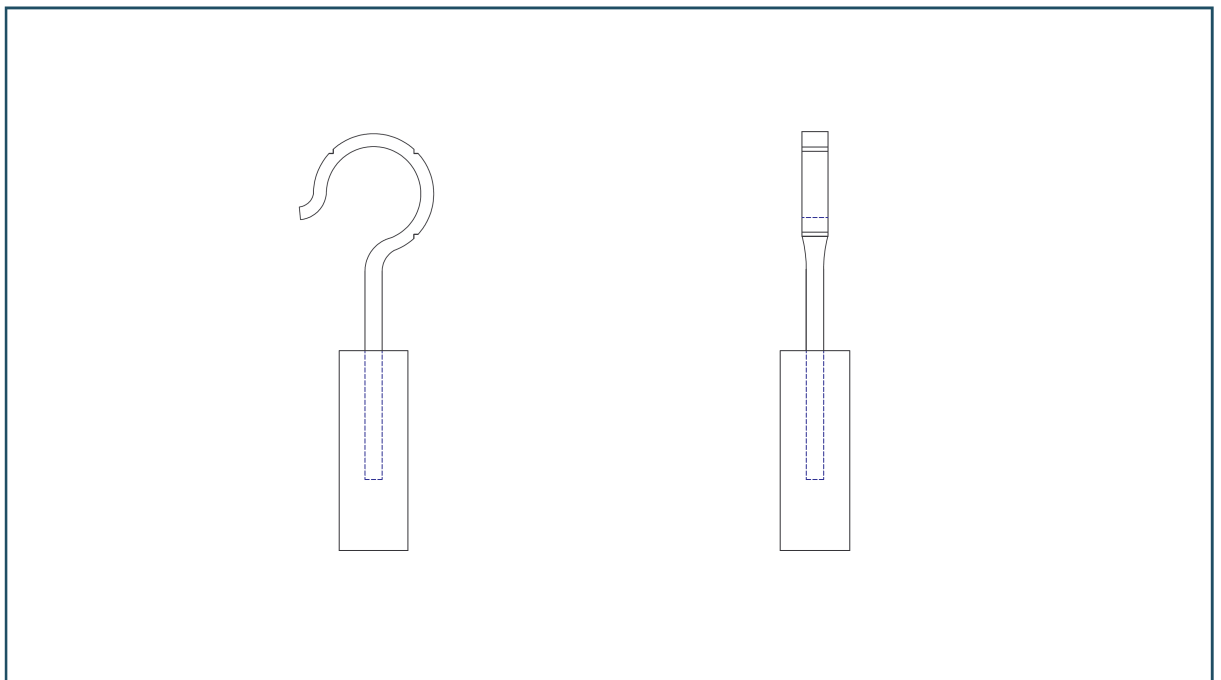

Dimensions

Total length (mm):

4.00 - 4.25 - 4.50 - 4.75

5.00 - 5.25 - 5.50 - 5.75

Piston diameter: 0.80 mm

Packaging

Dispenser box containing 6 sterile, individually packaged implants.

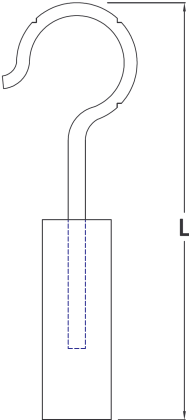
	Total length (L) mm	Code
	4.00	SPL 03.10.400
4.25	SPL 03.10.425	
4.50	SPL 03.10.450	
4.75	SPL 03.10.475	
5.00	SPL 03.10.500	
5.25	SPL 03.10.525	
5.50	SPL 03.10.550	
5.75	SPL 03.10.575	

